

Fire Alarm Interface

Vizulinx

Quick Start Guide

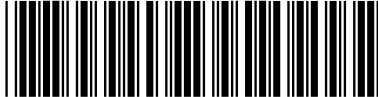

Safety

Suppliers of articles for use at work are required under section 6 of the Health and Safety at Work act 1974 to ensure as reasonably as is practical that the article will be safe and without risk to health when properly used.

An article is not regarded as properly used if it is used 'without regard to any relevant information or advice' relating to its use made available by the supplier.

This product should be installed, commissioned and maintained by trained service personnel in accordance with the following:

- EE regulations for electrical equipment in buildings
- Codes of practice
- Statutory requirements
- Any instructions specifically advised by The Manufacturer

According to the provisions of the Act you are therefore requested to take such steps as are necessary to ensure that you make any appropriate information about this product available to anyone concerned with its use.

The mains powered version of this equipment is designed to be operated from 230V 50Hz mains supplies and is of class 1 construction. As such it **must** be connected to a protective earthing conductor in the fixed wiring of the installation and a readily accessible double pole disconnect device shall be incorporated in the fixed wiring.

Failure to ensure that all conductive accessible parts of this equipment are adequately bonded to the protective earth will render the equipment unsafe.

Disclaimer

In no event shall The Manufacturer be liable for any damages or injury of any nature or kind, no matter how caused, that arise from the use of the equipment referred to in this manual.

Strict compliance with the safety procedures set out and referred to in this manual, and extreme care in the handling or use of the equipment, are essential to avoid or minimise the chance of personal injury or damage to the equipment.

The information, figures, illustrations, tables, specifications, and schematics contained in this manual are believed to be correct and accurate as at the date of publication or revision. However, no representation or warranty with respect to such correctness or accuracy is given or implied and The Manufacturer will not, under any circumstances, be liable to any person or corporation for any loss or damages incurred in connection with the use of this manual. The information, figures, illustrations, tables, specifications, and schematics contained in this manual are subject to change without notice.

Unauthorised modifications to the fire detection system or its installation are not permitted, as these may give rise to unacceptable health and safety hazards.

By installing this equipment on a computer network, the owner accepts full and unequivocal responsibility for ensuring that it is protected against all cyber threats and illegal tampering during the lifetime of the equipment. Any software forming part of this equipment should be used only for the purposes for which The Company supplied it. The user shall undertake no changes, modifications, conversions, translations into another computer language, or copies (except for a necessary backup copy). In no event shall The Manufacturer be liable for any equipment malfunction or damages whatsoever, including (without limitation) incidental, direct, indirect, special, and consequential damages, damages for loss of business profits, business interruption, loss of business information, or other pecuniary loss, resulting from any violation of the above prohibitions.

Vizulinx should not be used as primary notification and is to support and provide additional means of communication only.

Vizulinx Quick Start Guide

How to read this manual

- Thank you for purchasing this Kentec product. This guide provides a product overview and brief description of procedures required to get the system up and running. For detailed procedures, refer to the product manual.
- Be sure to read both this guide and the product manual.
- After you have finished reading the documents put them away in a safe place for future reference.
- For acquiring manuals please visit www.kentec.co.uk or contact techsupport@kentec.co.uk.
- Please note that specifications and software described in this guide (as well as hardware) are under development and may differ slightly.
- Please note depending on operating systems, web browser setting (etc), operation may differ from the procedures described in this guide.

Product Features

Vizulinx is a fire alarm management solution which enables you to monitor your fire alarm systems remotely. The module is configurable using an embedded web server and simple configuration through your web browser. It can be used to pass fire system events via e-mail, SMS, Modbus and BACnet message format using an IP connection.

What's in the box?

- The Vizulinx module (housed in enclosure - where specified)
- 2.5A power supply (where specified)
- Enclosure keys (as appropriate)
- 2x 10-way IDC GPIO input ribbon cables
- 1x 10-way IDC RS232 PC link ribbon cable
- 1x 14-way IDC PSU fault ribbon monitoring cable (supplied hard wired in housed versions)
- Vizulinx Quick Start Guide

QR Code

The QR code below provides a link to the **Vizulinx product manual**. Using your smartphone, tablet or device install a third party QR Code Reader and scan the code to open the document:



Should you be unable to work with the QR code, the Product Manual can be obtained by visiting the following web page:

Document	Website
Vizulinx Product Manual	http://www.kentec.co.uk/manuals/man-1428.pdf

Overview

The following diagrams provide an overview of the module hardware features:

Figure A-1
Overview of Vizulinx Module features

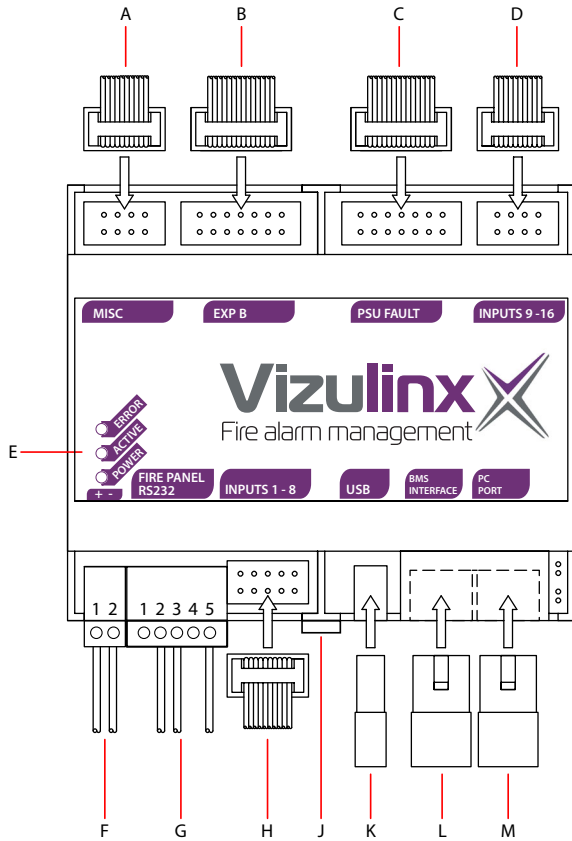

Key	Feature	Description
A	MISC	Not used.
B	EXP B	Not used.
C	PSU FAULT	Power supply unit fault monitoring input.
D	GPIO 9-16	Connection for Sigma CP, A-CP, XT, A-XT, XT+ (and other GPIO).
E	ERROR	When illuminated denotes an error.
	ACTIVE	When illuminated denotes activity: >15 seconds during boot up. 0.25 second flash every 10 seconds, denoting data being passed.
	POWER	When illuminated denotes power healthy.
F	POWER INPUT	Terminal 1: 9 - 30V DC.
		Terminal 2: 0V.
G	RS232 INPUT	For Syncro/Syncro AS connection
H	GPIO 1 - 8	Connection for Sigma CP, A-CP, XT, A-XT, XT+ (and other GPIO).
J	DIN Rail release tab	Pull down to release module.
K	USB	For USB A connectivity (GSM dongle, WIFI etc).
L	BMS INTERFACE	Ethernet connection to BMS or Taktis.
M	PC PORT	Ethernet connection to PC for programming or LAN.

Figure A-2
Overview of Vizulinx module housed - M2

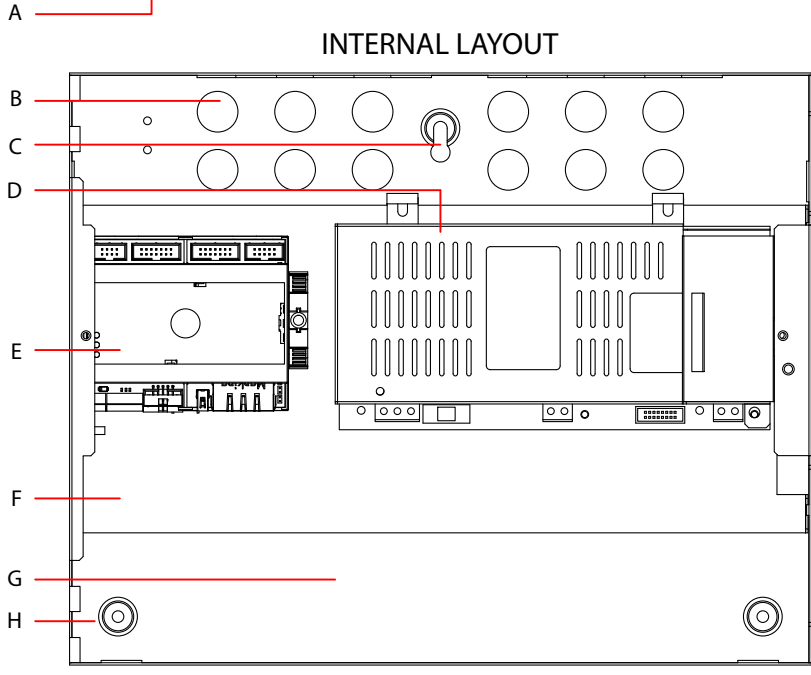
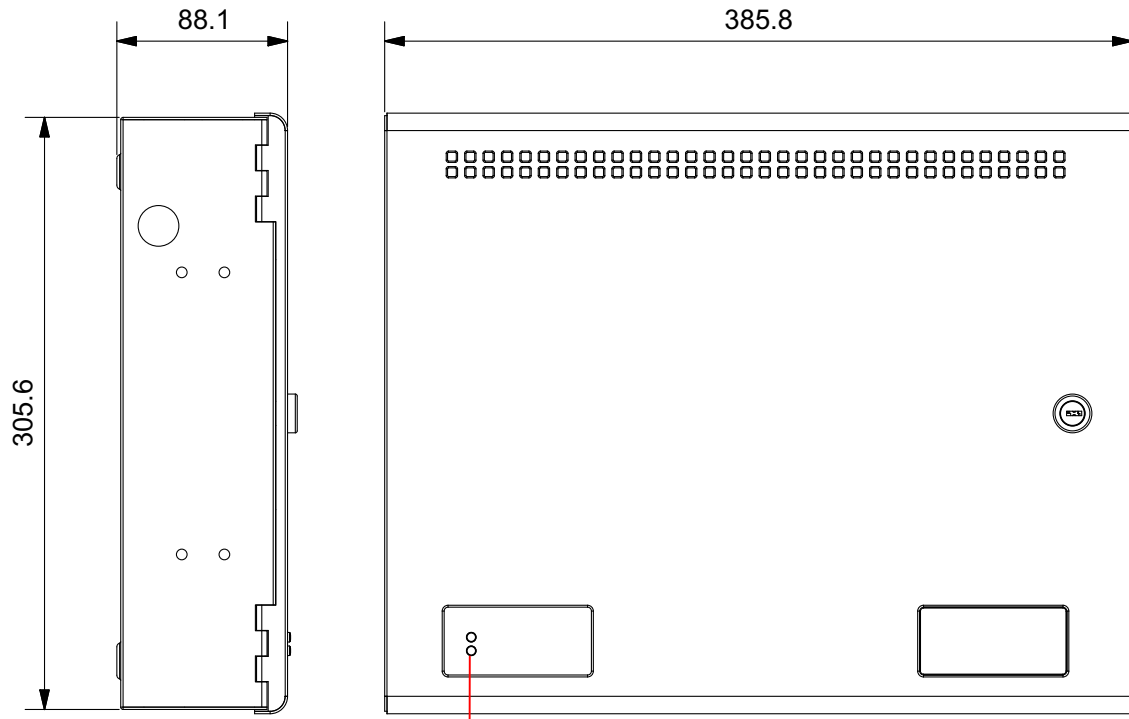

Key	Description
A	Power On/Power Fault status indicators
B	Knock-outs for cable entry
C	Upper enclosure fixing hole (x1)
D	Power supply
E	Vizulinx module
F	Enclosure chassis
G	Space for batteries
H	Lower enclosure fixing holes (x2)

For enclosure fixing positions refer to Vizulinx product manual.

Figure A-3
Overview of Vizulinx module housed - AM3

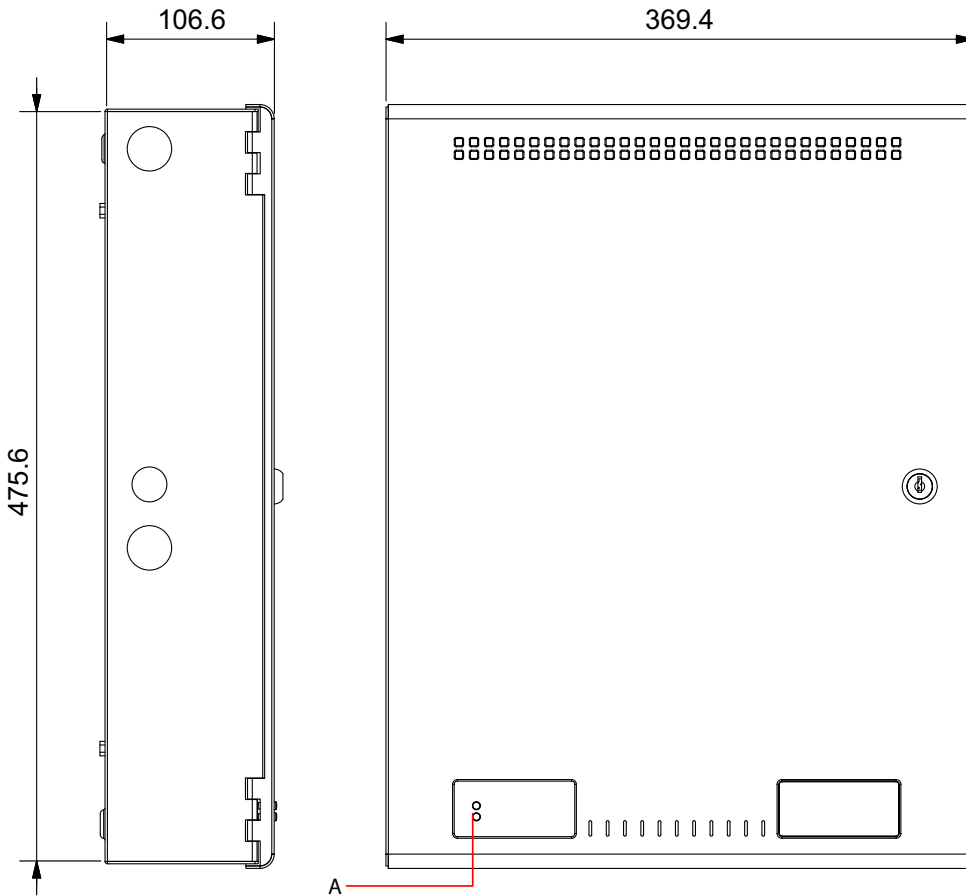

Key	Description
A	Power On/Power Fault status indicators
B	Enclosure earth block
C	Knock-outs for cable entry
D	Upper enclosure fixing holes (x2)
E	Vizulinx module
F	Power supply
G	Enclosure chassis
H	Space for batteries
J	Lower enclosure fixing holes (x2)

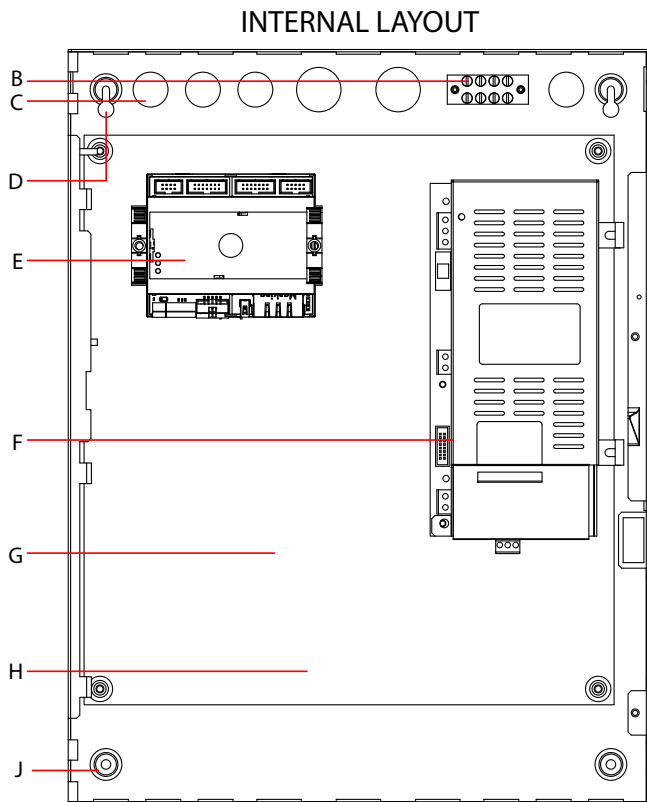

For enclosure fixing positions refer to Vizulinx Product Manual.

Setup Procedure

- Read all the documentation, create a plan for the installation, remove the module from its packaging and check the contents:
1. Mount the enclosure (or module, as specified):

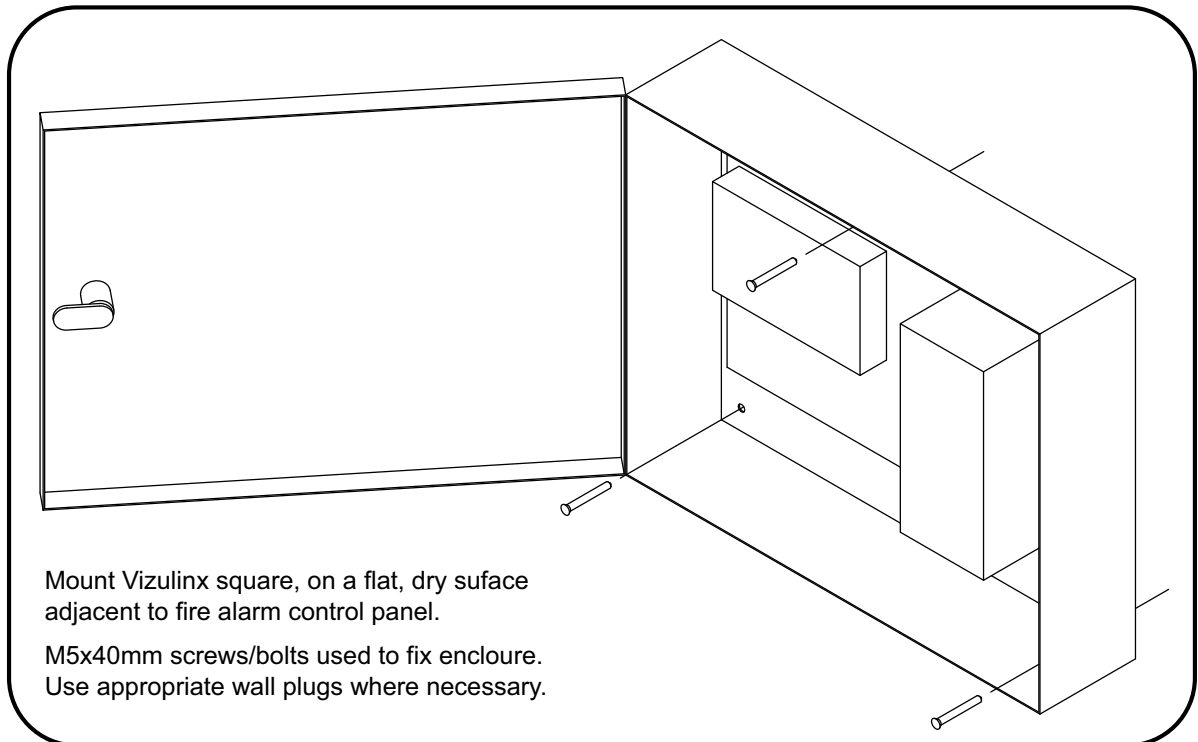

2. Connect cables (as appropriate).

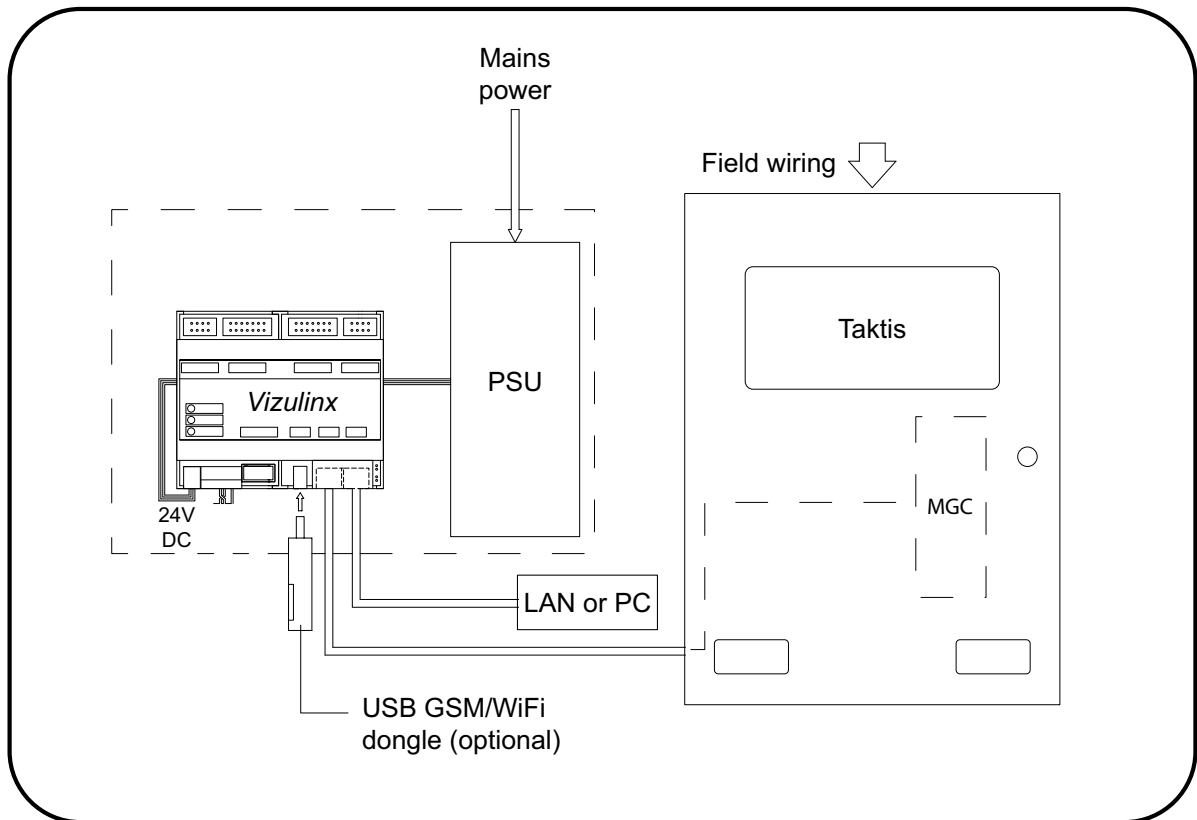
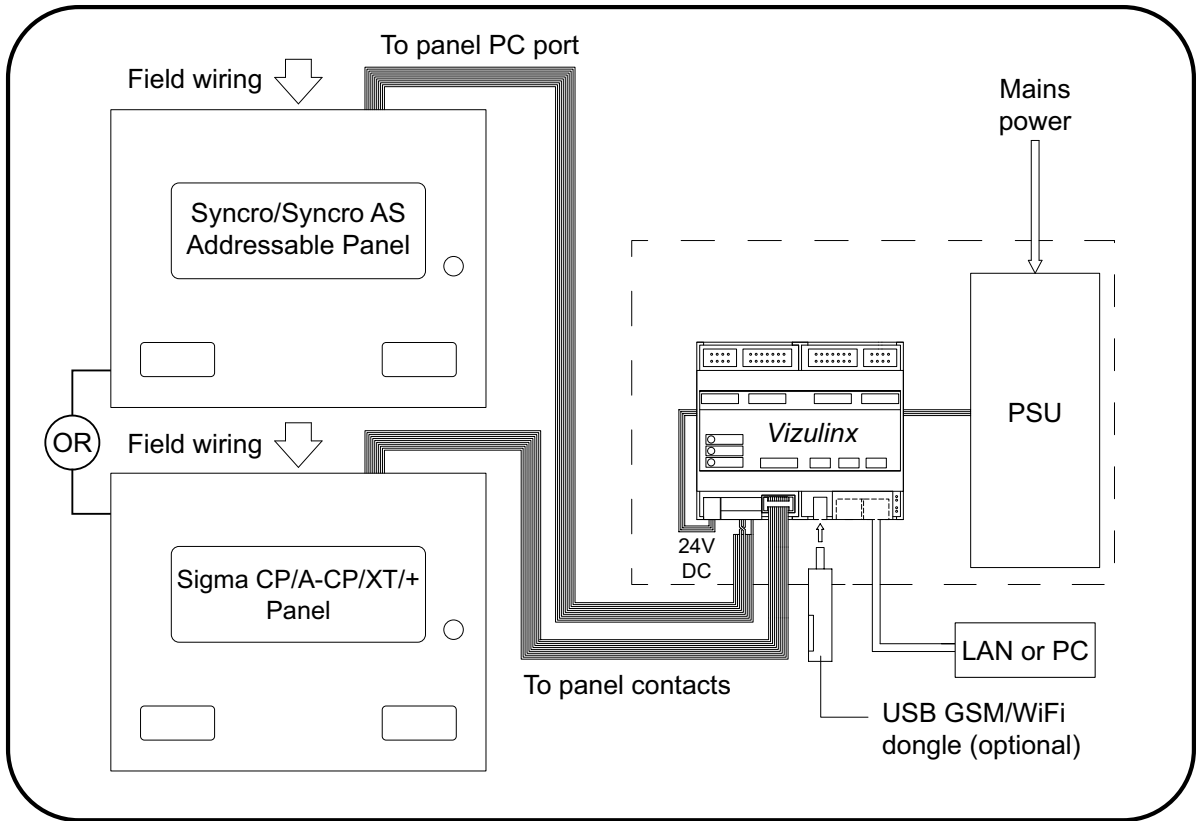

3. Configure PC settings:

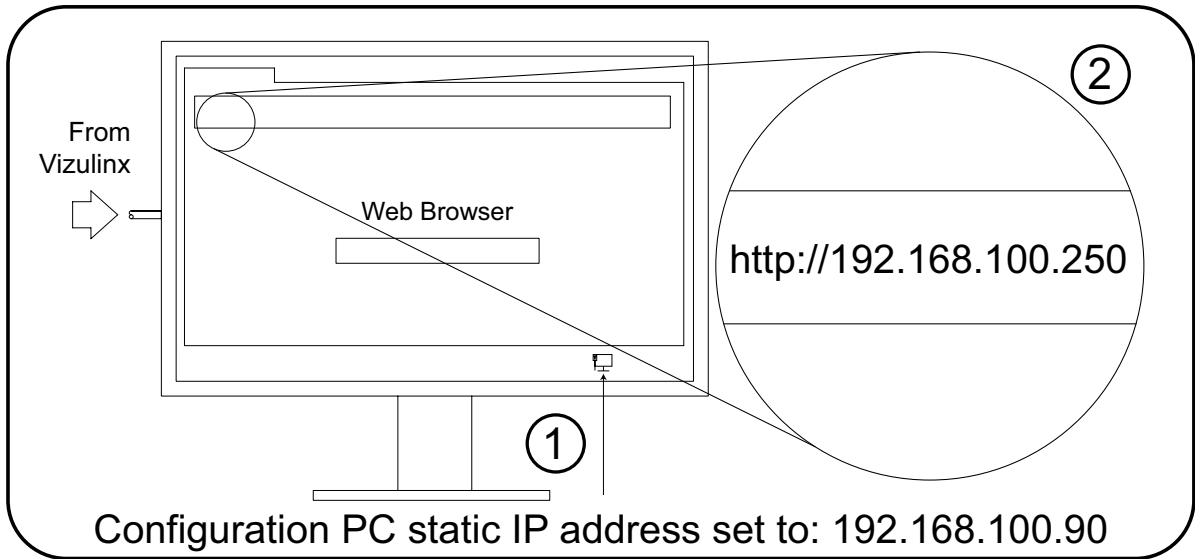

4. Login with your credentials to run start wizard and configure:

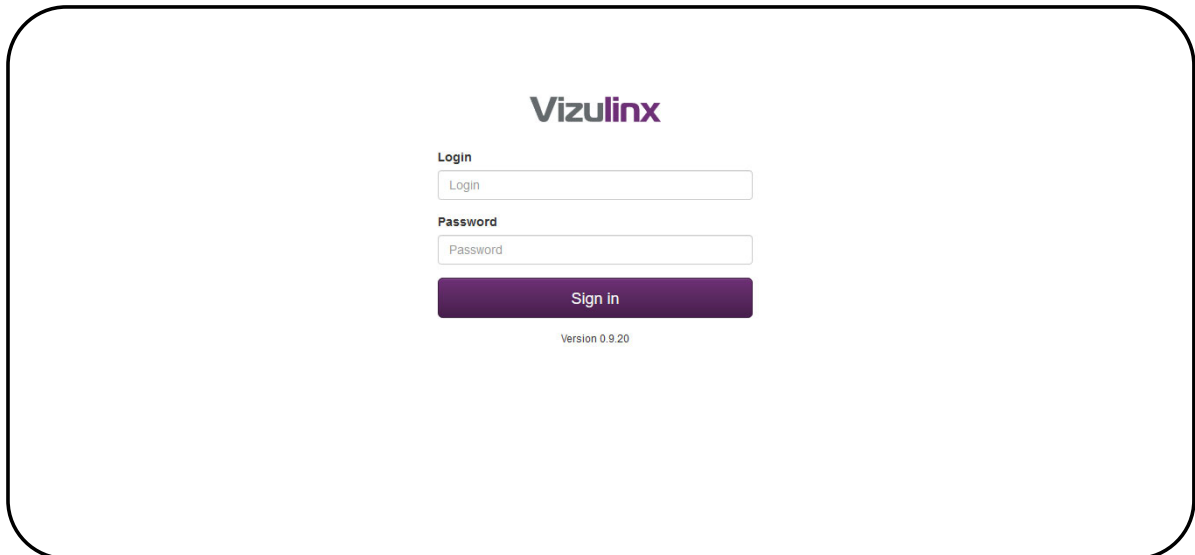

Specifications

Equipment			
Product Code	Description	Colour	Size WxHxD (mm)
K85000	Vizulinx - Module only	N/a	106 x 90 x 32
K85000 M2	Vizulinx - Housed version (M2)	Powder coat - Grey (BS-00-A-05)	385 x 310 x 90
K85110 AM3	Vizulinx - Housed version (AM3) 110V AC	Powder coat Red (RAL 3002)	369 x 481 x 110
K85240 AM3	Vizulinx - Housed version (AM3) 240V AC	Powder coat Red (RAL 3002)	369 x 481 x 110

Specifications		
K85000	module only operating voltage	9 - 30V DC
	module current consumption	200mA max @ 9V DC, 80mA max @ 30V DC
	Processor	AM3354 CPU 300-800-Mhz
	RAM	512MB
	1x USB type A port	For GSM and Wifi connectivity (via dongle)
	2x Ethernet ports	For connection to LAN and PC: Port 1 static IP (192.168.100.250) Port 2 DHCP assigned to plug into existing LAN
	Isolated RS232 port	Avoids ground faults
	16x General Purpose input/output	Inputs: 0v triggered, Outputs: default high switch low (0v). Provided in two groups of 8.
	3x Status LED's	Power (green), amber (activity), red (error)
Packaged weight	1kg	
K85000 M2 K85110 AM3 K85240 AM3	Power supply input voltage	K85000M2/K85240 AM3 - 230V AC +10%/-15% Model K85110 AM3 - 110V AC
	Power supply output current	2.5A (continuous)
	Standby battery capacity	K85000 M2 - 2 x 12V 7Ah SLA batteries (Yuasa NP) K85110 AM3/K85240 AM3 - 2 x 12V 12Ah SLA batteries (Yuasa NP)
	Packaged weight	3kg

Additional Information

Supported Operating System: Microsoft Windows.

Supported web browsers: Internet Explorer, Google Chrome, Mozilla Firefox, Opera

Contacting Kentec

Kentec Electronics Ltd.
25 Fawkes Avenue
Questor
Dartford
Kent
DA1 1JQ
United Kingdom

Tel: + 44 (0) 1322 222 121

www.kentec.co.uk
techsupport@kentec.co.uk.

